











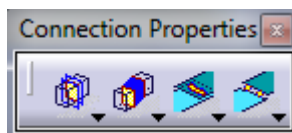

	Smooth Virtual Part
	Contact Virtual Part
	Rigid Virtual Part
	Rigid Spring Virtual Part
	Smooth Spring Virtual Part
	Periodicity Condition



	Rigid		Spot Welding
	Smooth		Seam Welding
	Virtual Bolt Tightening		Surface Welding
	Virtual Spring Bolt Tightening		Node to Node Connection Property
	Pressure Fitting		Node Interface Property

## Stress Analysis 1

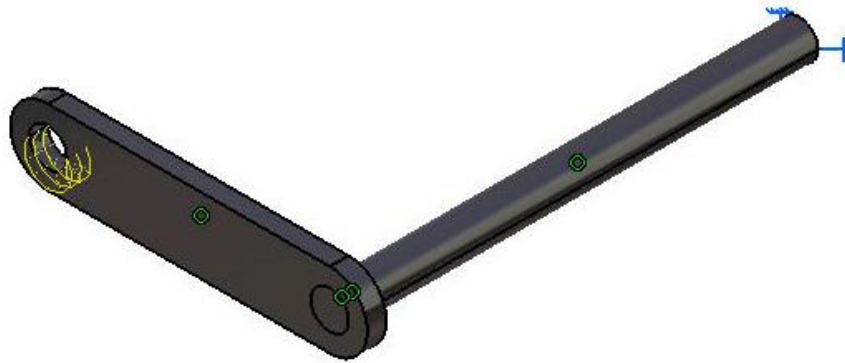

Von Mises stress (nodal values).2  
N\_m<sup>2</sup>

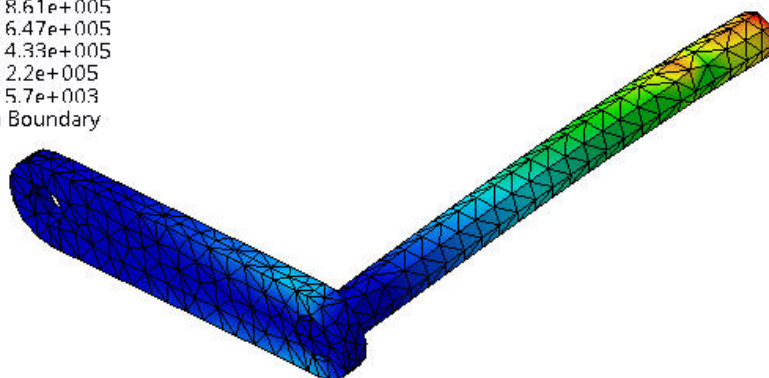
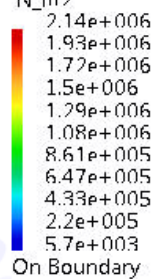

## Stress Analysis 2

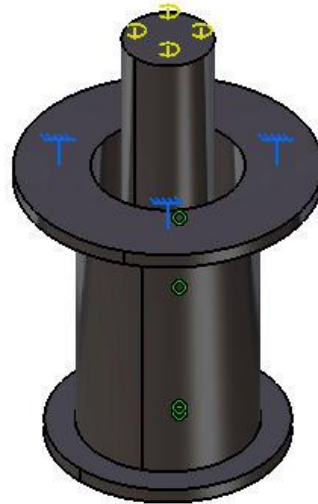

Von Mises stress (nodal values).1  
N\_m<sup>2</sup>  
453  
408  
363  
317  
272  
227  
182  
136  
90.9  
45.6  
0.36  
On Boundary

