

Start → Mechanical Design → Generative Sheetmetal Design

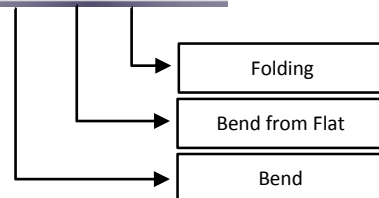
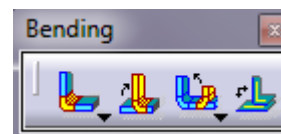
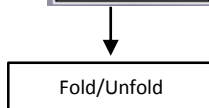
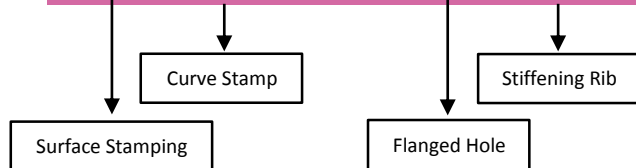
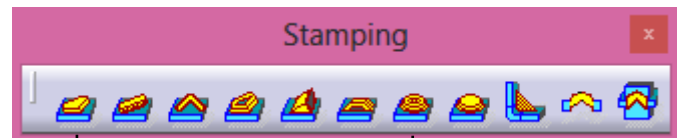
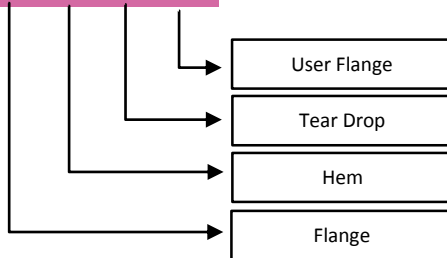
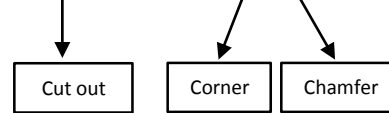
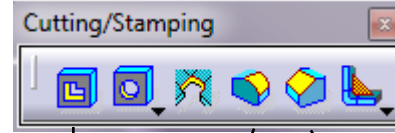
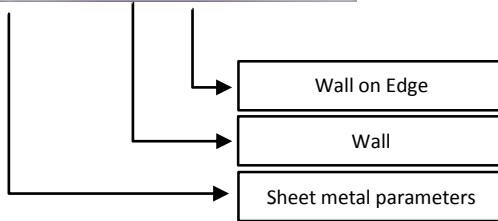

**Teacher:** Ehsan Fathi, PHD Student in Mechanical Engineering at University of Birjand

**Email:** Ehsanfathi\_eh@yahoo.com

**Telegram:** @FathiTrainingGroup

**Website:** FathiTrainingGroup.com

**Tel:** 09386249330

تمرین ۱

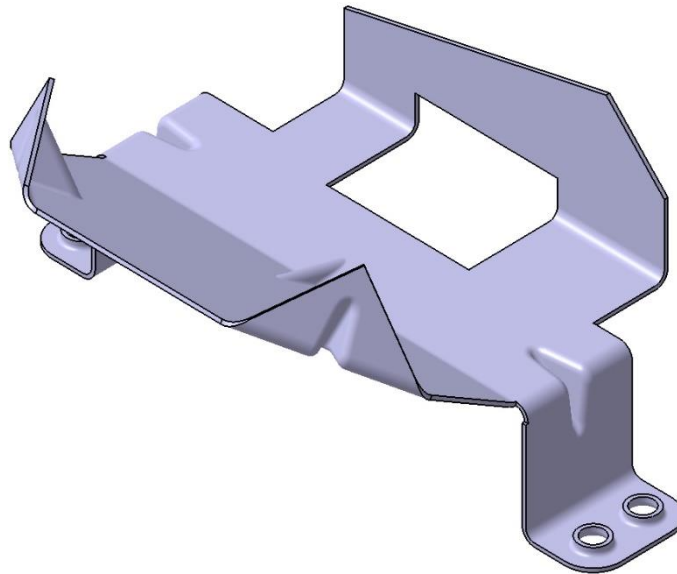

تمرین ۲

